

User Guide

**EVGA P67 SLI**

**Motherboard**



# Table of Contents

User Guide.....	1
EVGA P67 SLI Motherboard.....	1
Before You Begin.....	6
Parts NOT in the Kit.....	7
Intentions of the Kit.....	7
EVGA P67 SLI Motherboard.....	8
Motherboard Specifications.....	8
Unpacking and Parts Descriptions.....	10
Unpacking.....	10
Equipment.....	10
EVGA P67 SLI Motherboard.....	12
Hardware Installation.....	15
Safety Instructions.....	15
Preparing the Motherboard.....	16
Installing the CPU.....	16
Installing the CPU Fan.....	17
Installing System Memory (DIMMs).....	18
Installing the Motherboard.....	19
Installing the I/O Shield.....	19
Securing the Motherboard into the chassis.....	20
Connecting Cables.....	20
24-pin ATX Power (PW1).....	21
8-pin ATX 12V Power (PW12).....	22

## EVGA P67 SLI Motherboard

Bios Select Jumper.....	22
Connecting SATA Cables.....	23
Connecting Internal Headers.....	24
Front Panel Header .....	24
IEEE1394a (Firewire) .....	25
USB Headers .....	26
Audio Header .....	27
Fan Connections .....	28
Expansion Slots.....	29
PCI-E x1 Slots .....	30
PCI-E x16/x8 Slots .....	30
Onboard Buttons .....	31
Clear CMOS Button .....	31
RESET and POWER Button .....	31
Post Port Debug LED and LED Status Indicators.....	32
Post Port Debug LED .....	32
LED Status Indicators.....	32
Installing Drivers and Software.....	33
Windows XP/Vista/7 Driver Installation.....	33
Appendix A. POST Codes.....	34
EVGA Glossary of Terms .....	39
Compliance Information.....	42

## List of Figures

Figure 1.	EVGA P67 SLI Motherboard Layout .....	15
Figure 2.	Chassis Back Panel Connectors .....	14
Figure 3.	PW1 Motherboard Connector .....	21

## Before You Begin...

Thank you for purchasing the EVGA P67 SLI Motherboard. This board is based off of the new Intel P67 chipset with native support for SATA III/6G for the performance you demand, delivered when you need it.

As always this board comes with the added bonus of EVGA's industry leading 24/7 technical support in case you ever have any issues or questions.

---

## Parts NOT in the Kit

This kit contains all the hardware necessary to install and connect your new EVGA P67 SLI Motherboard. However, it does not contain the following items that must be purchased separately to make the motherboard functional.

- ❑ **Intel Socket 1155 Processor**
- ❑ **DDR3 System Memory**
- ❑ **Socket 775 or 1155/1156 CPU cooler for the processor**
- ❑ **PCI Express Graphics Card**
- ❑ **Power Supply**

EVGA assumes you have purchased all the necessary parts needed to allow for proper system functionality. For a full list of supported CPU's on this motherboard, please visit <http://www.evga.com/support/motherboard/>.

---

## Intentions of the Kit

This kit provides you with the motherboard and all connecting cables necessary to install the motherboard into a PC case. If you are *building* a PC, you will use most of the cables provided in the kit. If however, you are *replacing* a motherboard, you will not need many of the cables.

When *replacing* a motherboard in a PC case, you will need to reinstall an operating system even though the current Hard Disk Drive may already have one installed.

# EVGA P67 SLI Motherboard

---

## Motherboard Specifications

- ❑ Size  
ATX form factor of 12 inches x 9.6 inches
- ❑ Microprocessor support  
Intel Socket 1155 Processor
- ❑ Operating systems:  
Supports Windows XP/Vista/7 32 and 64 bit
- ❑ Contains Intel P67 chipset
- ❑ System Memory support  
Supports Dual channel DDR3-1333+. Officially supports up to 16GBs of DDR3 memory.
- ❑ USB 2.0 Ports  
Supports hot plug  
Ten USB 2.0 ports (Six rear panel ports, four onboard USB headers)  
Supports wake-up from S1 and S3 mode  
Supports USB 2.0 protocol up to a 480 Mbps transmission rate
- ❑ USB 3.0 Ports  
Two USB 3.0 ports (on I/O panel)  
Backwards compatible USB 2.0 and USB 1.1 support  
Supports transfer speeds up to 5Gbps



- ❑ Five (5) onboard SATA ports up to 3.0 Gb/s (300 M/s)  
data transfer rate  
Two (2) SATA ports up to 6.0 Gb/s (600 M/s) data transfer rate  
Five SATA ports from P67Chipset support for RAID 0, RAID 1, RAID 0+1, RAID5 and RAID 10  
One ESATA supports 3.0 Gb/s (on I/O panel)
- ❑ Onboard LAN  
Integrated Dual LAN ports  
Supports 10/100/1000 Mbit/sec Ethernet
- ❑ Onboard IEEE 1394a (Firewire)  
Supports hot plug  
Two IEEE 1394a ports (one rear panel port, one onboard header) with a rate transmission of 400 Mbps
- ❑ Onboard Audio  
Realtek High-Definition audio  
Supports 8-channel audio  
Supports Jack-Sensing function
- ❑ PCI-E Support  
Three (3) PCI-E 2.0 Slots  
Low power consumption and power management features
- ❑ Green Function  
Supports ACPI (Advanced Configuration and Power Interface)  
Supports S0 (normal), S1 (power on suspend), S3 (suspend to RAM), S4 (Suspend to disk - depends on OS), and S5 (soft - off)
- ❑ Expansion Slots  
Three PCI-E x1 slots  
One PCI-E x4 slot  
Two PCI-E x8/x16 slots

# Unpacking and Parts Descriptions

---

## Unpacking

The EVGA P67 SLI Motherboard comes with all the necessary cables for adding a motherboard to a system case. If replacing a motherboard, you may not need many of these cables.

---

## Equipment

The following accessories are included with the EVGA P67 SLI Motherboard:



---

### The EVGA P67 SLI Motherboard

This PCI-E motherboard contains the Intel P67 chipset and is SLI-ready for 2-way SLI configurations.



---

### 1 - Visual Guide

Helps to quickly and visually guide you through the hardware installation of the motherboard.



---

### 1 - I/O Shield

Installs in the system case to block radio frequency transmissions, protect internal components from dust, foreign objects, and aids in proper airflow within the chassis.

---



**2 - 2-Port SATA Power Cables**

Allows a Molex power connector to adapt to a SATA power connector.



**1 - 2-Port USB 2.0 / 1394a Firewire Bracket**

Provides two additional USB ports and 1 additional 1394a Firewire port to the back panels of the chassis.



**2 – SATA II/3G Data Cables**

Used to support the SATA protocol and each one connects a single drive to the motherboard.



**2 – SATA III/6G Data Cables**

Used to support the SATAIII/6G high speed protocol and each one connects a single drive to the motherboard.



**1 - 2-way SLI Bridge**

Bridges two (2) graphics cards together which allows for 2-way SLI.



**1 - Installation CD**

Contains drivers and software needed to setup the motherboard.



**1 – User Manual**

Contains Information needed to properly install and configure your EVGA Motherboard.

---

---

## EVGA P67 SLI Motherboard

The EVGA P67 SLI Motherboard with the Intel P67 chipset is an SLI-ready motherboard. Figure 1 shows the motherboard and Figure 2 shows the back panel connectors.

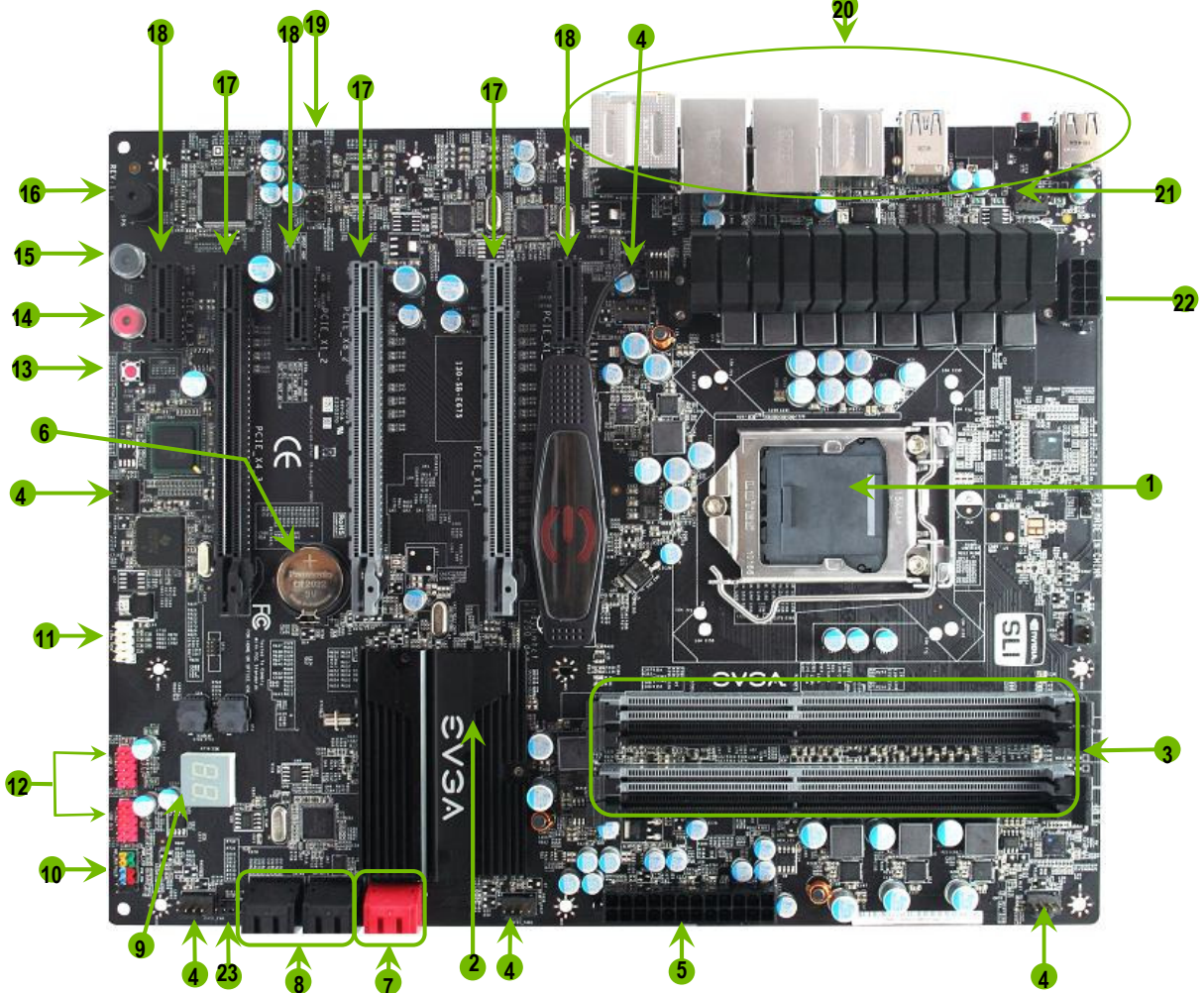

1. CPU Socket 1155	11. IEEE 1394a Connector	21. CPU Fan Connector
2. Intel P67 Chipset	12. USB Headers	22. 8-pin ATX_12V Power Connector
3. DDR3 DIMM Slots 1 – 4	13. Clear CMOS Button	23. BIOS Chip Selection Jumper
4. Fan Connectors	14. Power Button	
5. 24-Pin ATX Power Connector	15. Reset Button	
6. Motherboard Battery	16. PC Speaker	
7. SATA III connectors	17. PCI-E 2.0 Slot	
8. SATA II Connectors	18. PCI-E x1 Slot	
9. Debug LED Display - CPU Temperature Monitor	19. Front Panel Audio Connector/SPDIF Connector	
10. Front Panel Connector	20. Back Panel Connectors (Figure 2)	

Figure 1. EVGA P67 SLI Motherboard Layout

EVGA P67 SLI Motherboard

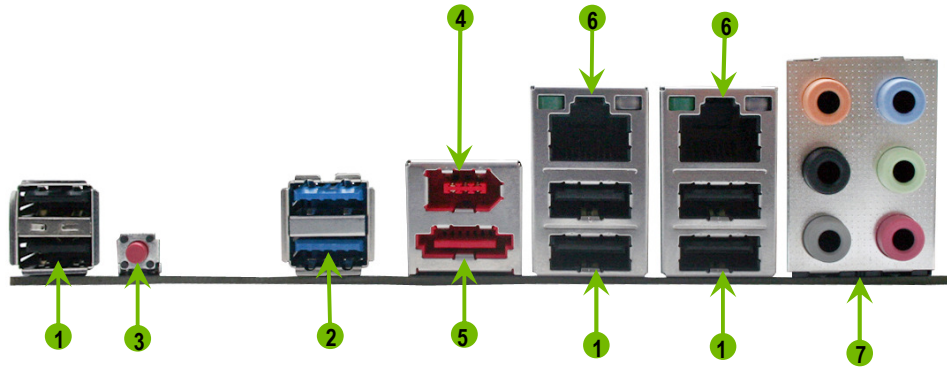

1. USB 2.0 ports (six)
2. USB 3.0 ports (two)
3. Clear CMOS Button
4. IEEE 1394a (Firewire) Port
5. ESATA port (Shared with SATA port 4a/b)
6. Dual LAN Ports with LEDs to indicate status:

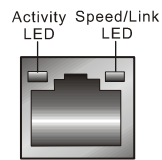

Activity LED Status	Description
Off	No data transmission
Blinking (Green)	Data transmission

Speed/Link LED Status	Description
Yellow	1000 Mbps data rate
Green	100 Mbps data rate
Off	10 Mbps data rate

7. Audio Port	2-Channel	6-Channel	8-Channel
Blue	Line-In	Line-In	Line-In
Green	Line-Out	Front Speaker Out	Front Speaker Out
Pink	Mic In	Mic In	Mic In
Orange		Center/Subwoofer	Center/Subwoofer
Black		Rear Speaker Out	Rear Speaker Out
Grey			Side Speaker Out

Figure 2. Chassis Back Panel Connectors

# Hardware Installation

This section will guide you through the installation of the motherboard. The topics covered in this section are:

- ❑ Preparing the motherboard
- ❑ Installing the CPU
- ❑ Installing the CPU fan
- ❑ Installing the memory
- ❑ Installing the motherboard
- ❑ Connecting cables

---

## Safety Instructions

**To reduce the risk of fire, electric shock, and injury, always follow basic safety precautions.**

**Remember to remove power from your computer by disconnecting the AC main source before removing or installing any equipment from/to the computer chassis.**

---

## Preparing the Motherboard

### Installing the CPU

Be very careful when handling the CPU. Hold the processor only by the edges and do not touch the bottom of the processor.

Use the following procedure to install the CPU onto the motherboard:

Unhook the socket lever by pushing *down* and *away* from the socket.

Pull the socket lever back and the load plate will automatically lift. There is a protective socket cover within the CPU socket to protect the socket when there is no CPU installed.

Remove the protective socket cover from the CPU Socket.

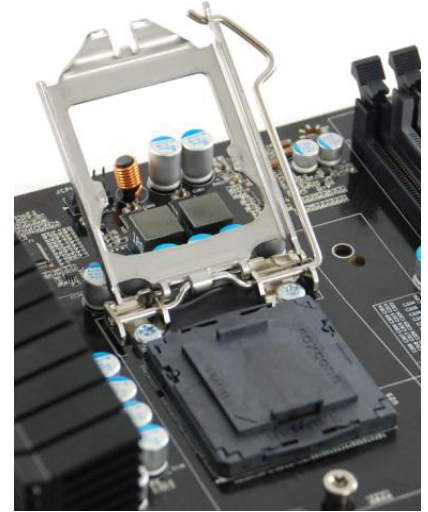
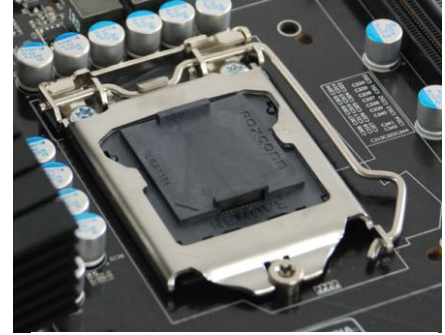

---

**Note:** After removing the CPU socket cover, it is recommended that you keep it in case you need to remove the CPU so for any reason you can replace the cover to avoid damaging the CPU socket pins.

---



Align the notches in the processor with the notches on the socket.

Lower the processor straight down into the socket with out tilting or sliding it into the socket.

**Note:** Make sure the CPU is fully seated and level in the socket.

Close the load plate over the CPU and press down while you close and engage the socket lever.

The CPU installation is complete.

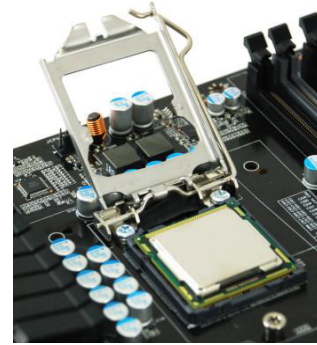

Align notches with notches on the CPU



## Installing the CPU Fan

There are many different fan types that can be used with this motherboard. Follow the instruction that came with your fan assembly. Be sure that the fan orientation is correct for your chassis type and your fan assembly.

Please note that there are 2 sets of mounting holes, there are holes to be used for Socket 1156 and 1155 heatsinks and are labeled. The other holes are to be used for Socket 775 heatsinks.

In most cases, the Socket 1156/1155 mounting holes will be used.

## Installing System Memory (DIMMs)

Your new motherboard has four 240-pin slots for DDR3 memory. These slots support 1GB, 2GB and 4GB DDR3 DIMMs. There must be at least one memory slot populated to ensure normal operation. Use the following the recommendations for installing memory. (See Figure 1 on page 13 for the location of the memory slots.)

- ❑ **One DIMM:** If using 1 DIMM (**Single Channel**), install into: **DIMM slot 1.**
- ❑ **Two or Four DIMMs:** If using 2 DIMMs (**Dual Channel**), install into: **DIMM slots 1 and 3.** If using 4 DIMMs (**Dual Channel**), install into: **DIMM slots 1, 2, 3, and 4.**



Use the following procedure to install DIMMs. Note that there is only one gap near the center of the DIMM slot. This slot matches the slot on the DIMM to ensure the component is installed properly.

1. Unlock a DIMM slot by pressing the module clips outward.

Align the memory module to the DIMM slot, and insert the module vertically into the DIMM slot. The plastic clips at both sides of the DIMM slot automatically lock the DIMM into the connector.

---

## Installing the Motherboard

The sequence of installing the motherboard into a system case depends on the chassis you are using and if you are replacing an existing motherboard or working with an empty system case. Determine if it would be easier to make all the connections prior to this step or to secure the motherboard and then make all the connections. It is normally easier to secure the motherboard first.

Use the following procedure to install the I/O shield and secure the motherboard into the chassis.

**Note:** Be sure that the CPU fan assembly has enough clearance for the system case covers to lock into place and for the expansion cards. Also make sure the CPU Fan assembly is aligned with the vents on the covers. This will depend on the system case being used.

## Installing the I/O Shield

The motherboard kit comes with an I/O shield that is used to block radio frequency transmissions, protects internal components from dust and foreign objects, and promotes correct airflow within the chassis.

Before installing the motherboard, install the I/O shield from the *inside* of the chassis. Press the I/O shield into place and make sure it fits securely. If the I/O shield does not fit into the chassis, you would need to obtain the proper size from the chassis supplier.

## Securing the Motherboard into a System Case

Most system cases have a base with mounting studs or spacers to allow the motherboard to be secured to the chassis and help to prevent short circuits. If there are studs that do not align with a mounting hole on the motherboard, it is recommended that you remove that stud to prevent the possibility of a short circuit. In most cases, it is recommended to secure the motherboard using a minimum of nine (9) spacers and screws.

1. Carefully place the motherboard onto the stand offs located inside the chassis.
2. Align the mounting holes with the stand offs.
3. Align the connectors to the I/O shield.
4. Ensure that the fan assembly is aligned with the chassis vents according to the fan assembly instruction.
5. Secure the motherboard with a recommended minimum of nine (9) screws.

---

## Connecting Cables

This section takes you through all the necessary connections on the motherboard. This will include:

- ❑ Power Connections
  - 24-pin ATX power (**PW1**)
  - 8-pin ATX 12V power (**PW12**)
- ❑ Internal Headers
  - Front Panel Header
  - IEEE 1394a Header
  - USB Headers
  - Audio Header
- ❑ SATA II
- ❑ SATA III
- ❑ Chassis Fans
- ❑ USB 2.0

- ❑ Expansion slots
- ❑ CMOS Clear Button

## 24-pin ATX Power (PW1)

**PW1** is the main power supply connector located along the edge of the board next to the DIMM slots. Make sure that the power supply cable and pins are properly aligned with the connector on the motherboard. Firmly plug the power supply cable into the connector and make sure it is secure.



**PW1** connector  
Plug power cable from system power supply to PW1

Board edge

Figure 3. PW1 Motherboard Connector

Table 1. PW1 Pin Assignments

Connector	Pin	Signal	Pin	Signal
	1	+3.3V	13	+3.3V
	2	+3.3V	14	-12V
	3	GND	15	GND
	4	+5V	16	PS_ON
	5	GND	17	GND
	6	+5V	18	GND
	7	GND	19	GND
	8	PWROK	20	RSVD
	9	+5V_AUX	21	+5V
	10	+12V	22	+5V
	11	+12V	23	+5V
	12	+3.3V	24	GND

## 8-pin ATX 12V Power (PW12)

**PW12**, the 8-pin ATX 12V power connection, is used to provide power to the CPU. Align the pins to the connector and press firmly until seated.

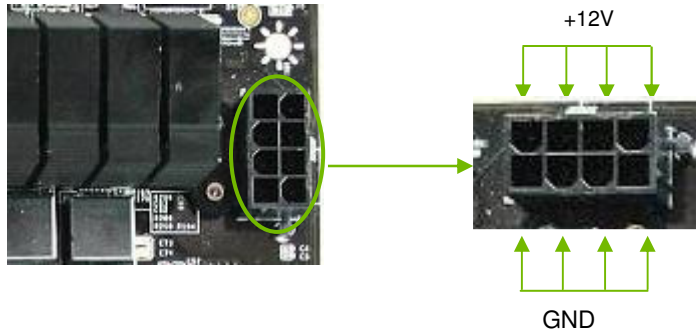

## BIOS Select Jumper

The BIOS Select Jumper is located directly beneath the SATA ports on the right side of the mainboard. (Pg 15 Figure 1 Item number 23) This jumper controls which of two (2) physical BIOS chips are to be used when the system is powered on.

The addition of 2 physical BIOS chips on the mainboard allows for usage of two completely different bios versions or saving of profiles to differentiate between bench sessions and regular 24/7 usage.

## Connecting SATA Cables

The SATA II connector is used to connect the SATA II device to the motherboard. These connectors support the thin SATA II cables for primary storage devices. The current SATA II interface allows up to 300MB/s data transfer rate.

There are five (5) internal SATA connectors on this motherboard. Connection points SATA0 – SATA4 (Black in color), are controlled by the P67 Chipset and operate at a speed up to 300MB/s.

There is also a ESATA port on the rear panel which is operated by the P67 Chipset.

The onboard ports that are red in color are SATA III ports and operate from the P67 chipset at a transfer rate up to 600MB/s

\*\*NOTE: SATA port 4a/b is a single data port, and therefore you can use port A or B but both cannot operate at the same time.

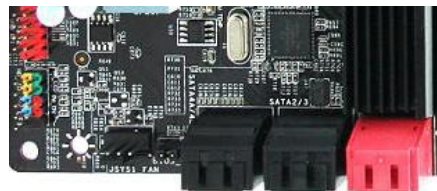

SATA 4a (bottom)    SATA 2 (bottom)    SATA 0 (bottom)  
 SATA 4b (top)      SATA 3 (top)            SATA 1 (top)

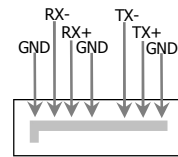

Connect the locking cable end to the motherboard connector.  
 Connect the end without the lock to the SATA device.

## Connecting Internal Headers

### Front Panel Header

The front panel header on this motherboard is one connector used to connect the following four cables.

(see Table 2 for pin definitions):

❑ **PWRLED**

Attach the front panel power LED cable to these two pins of the connector. The Power LED indicates the system's status. When the system is powered on, the LED will be on. When the system is turned off, the LED is off. When the system is in S1, S3, S4 status, the LED will blink.

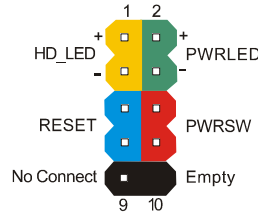

**Note:** Some system cases do not have all four cables. Be sure to match the name on the connectors to the corresponding pins.

❑ **PWR SW**

Attach the power button cable from the case to these two pins. Pressing the power button on the front panel turns the system on and off rather than using the onboard button.

❑ **HD\_LED**

Attach the hard disk drive indicator LED cable to these two pins. The HDD indicator LED indicates the activity status of the hard disks.

❑ **RESET**

Attach the Reset switch cable from the front panel of the case to these two pins. The system restarts when the **RESET** switch is pressed.

Table 2. Front Panel Header Pins

	Pin	Signal
<b>HD_LED</b>	1	HD_PWR
	3	HD Active
<b>PWRLED</b>	2	PWR LED
	4	STBY LED
<b>RESET</b>	5	Ground
	7	RST BTN
<b>PWR SW</b>	6	PWR BTN
	8	Ground
<b>No Connect</b>	9	+5V
<b>Empty</b>	10	Empty



## IEEE 1394a (Firewire)

The IEEE 1394a expansion cable bracket is provided in the box but if you do not require the additional external connections, you do not need to install it.

1. Secure the bracket to either the front or rear panel of the system case (not all system cases are equipped with the front panel option).

Connect the end of the cable(s) to the IEEE 1394a headers on the motherboard.

Table 3. IEEE 1394a Connector Pins

Connector	Pin	Signal
IEEE 1394a Connector	1	TPA+
	2	TPA-
	3	GND
	4	GND
	5	TPB+
	6	TPB-
	7	+12V
	8	+12V
	9	Empty
	10	GND

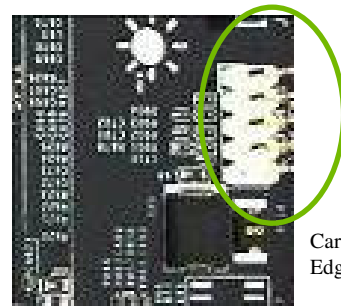
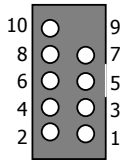

Card Edge

## USB Headers

This motherboard contains six (6) USB 2.0 ports that are exposed on the rear panel of the chassis (Figure 2). The motherboard also contains two 10-pin internal header connectors onboard that can be used to connect an optional external bracket containing up to four (4) USB 2.0 ports.

1. Secure the bracket to either the front or rear panel of your chassis (not all chassis are equipped with the front panel option).
2. Connect the two ends of the cables to the USB 2.0 headers on the motherboard.

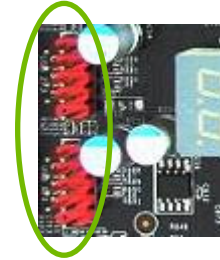
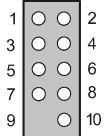

Table 4. USB 2.0 Header Pins

Connector	Pin	Signal
USB 2.0 Header Connector  	1	5V_DUAL
	3	D-
	5	D+
	7	GND
	9	Empty
	Pin	Signal
	2	5V_DUAL
	4	D-
	6	D+
	8	GND
10	No Connect	

## Audio

The audio connector supports HD audio standard and provides two kinds of audio output choices: the Front Audio and the Rear Audio. The Front Audio supports re-tasking function.

Table 5. Front Audio Connector

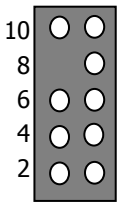
Connector	Pin	Signal
Front Audio Connector 	1	PORT1_L
	2	AUD_GND
	3	PORT1_R
	4	PRECENCE_J
	5	PORT2_R
	6	SENSE1_RETURN
	7	SENSE_SEND
	8	Empty
	9	PORT2_L
	10	SENSE2_RETURN



Card Edge

## Fan Connections

### Power Fan

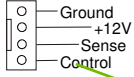

There are seven fan connections on the motherboard. The fan speed can be detected and viewed in the BIOS. The fans are automatically turned off after the system enters S3, S4 and S5 mode.

### CPU Fan

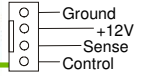

### Chassis Fan

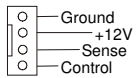

### System Fan

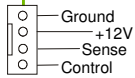

### AUX Fan

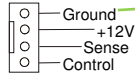

Note: the CPU fan cable can be either a 3-pin or a 4-pin connector. Connect a 3-pin connector to pins 1, 2, and 3 on the motherboard connector.

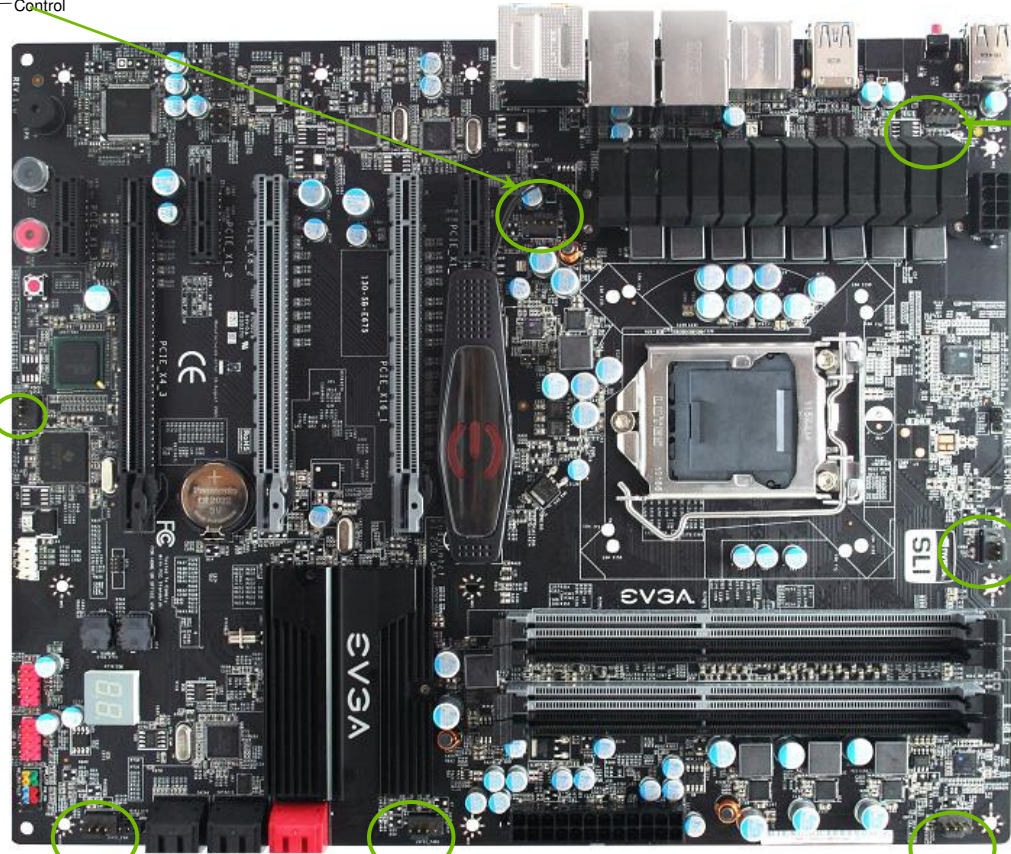
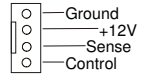

## Expansion Slots

The EVGA P67 SLI Motherboard contains six (6) expansion slots, three (3) PCI-E x16 length slots and three (3) PCI-E x1 slots. For a full list of PCI-E graphic cards supported by this motherboard, visit: [www.EVGA.com/Products](http://www.EVGA.com/Products)

6 5 4 3 2 1

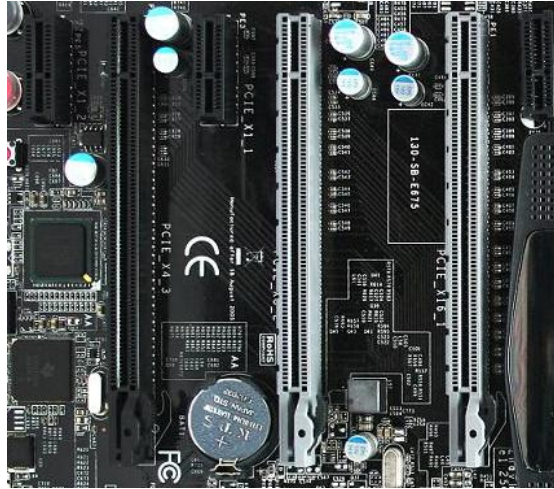

### Slot Listing

- 1 - PCI-E x1 - Slot 1
- 2 - PCI-E 2.0 x8/x16 - Slot 1
- 3 - PCI-E 2.0 x8 - Slot 2
- 4 - PCI-E x1 - Slot 2
- 5 - PCI-E x4 - Slot 3
- 6 - PCI-E x1 - Slot 3

**Note:** When using 1 Graphics Card in PCI-E: Slot 2, a speed of x16 will be used.  
When using 2 Graphics Cards in PCI-E Slots: 2 and 3, a speed of x8/x8 will be used.

## PCI-E x1 Slots

There are three PCI-E x1 slots that are designed to accommodate less bandwidth-intensive cards, such as a modem, sound or LAN card.

## PCI-E x16/x8 Slots

These PCI-E slots are reserved for Graphics Cards and PCI-E x1, x4, x8 and x16 devices. The design of this motherboard supports multiple Graphics Card technologies such as SLI or CrossFireX.

When installing a PCI-E Graphics Card, be sure the retention clip snaps and locks the card into place. If the card is not seated properly, it could cause a short across the pins. Secure the card's metal bracket to the chassis back panel with the screw used to hold the blank cover.

## Onboard Buttons

These onboard buttons include RESET, POWER and Clear CMOS. These functions allow you to easily reset the system, turn on/off the system, or clear the CMOS.

### Clear CMOS Button

The motherboard uses the CMOS RAM to store all the set parameters. The CMOS can be cleared by pressing the Clear CMOS button either onboard or on the external I/O Panel.

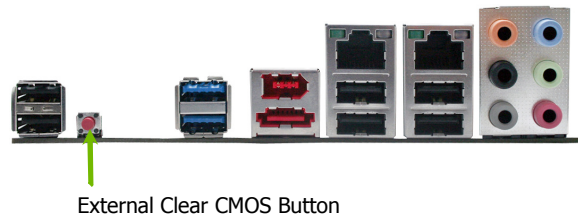

### RESET and POWER Button

These onboard buttons allow you to easily turn on/off the system. These buttons allow for easy debugging and testing of the system during troubleshooting situations.

The POWER button with an integrated LED indicates the system's status. When the system is powered on, the LED remains a solid red.

The RESET button with an integrated LED indicates the activity status of the hard disk drives and will flicker accordingly.

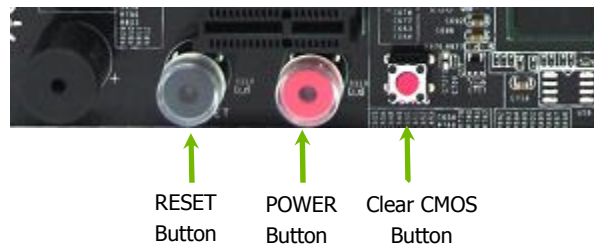

---

## Post Port Debug LED and LED Status Indicators

### Post Port Debug LED

Provides two-digit POST codes to show why the system may be failing to boot. It is useful during troubleshooting situations. This Debug LED will also display current CPU socket temperatures after the system has fully booted into the Operating System.



Debug LED with CPU Temperature Monitor

### LED Status Indicators

These LEDs indicate the system's status.

- ❑ POWER LED (Yellow):  
When the System is powered on: This LED is on.
- ❑ DIMM LED (Green):  
When the Memory slot is functional: This LED is on.
- ❑ STANDBY LED (Blue):  
When the System is in Standby Mode: This LED is on. This LED will remain on as long as the motherboard is receiving constant power.

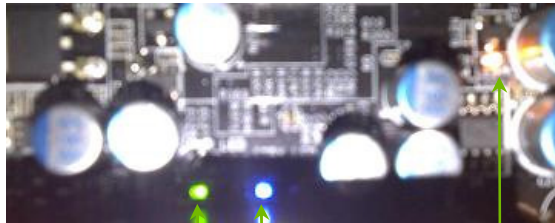

DIMM LED (GREEN)

STANDBY LED (BLUE)

POWER LED (YELLOW)



# Installing Drivers and Software

**Note:** It is important to remember that *before* installing the driver CD that is shipped in the kit, you need to load your operating system. The motherboard supports Windows XP , Vista and Windows 7 both 32 and 64 Bit.

The kit comes with a CD that contains utilities, drivers, and additional software.

The CD that has been shipped with the EVGA P67 SLI Motherboard contains the following software and drivers:

- ❑ Chipset Drivers
- ❑ Audio Drivers
- ❑ RAID Drivers
- ❑ LAN Drivers
- ❑ Matrix Storage
- ❑ NEC USB 3.0 Drivers
- ❑ EVGA E-LEET
- ❑ User's Manual

---

## Windows XP/Vista/Win 7 Driver Installation

1. Insert the EVGA P67 installation CD for the motherboard included in the kit.
2. The CD will autorun, install the drivers and utilities listed on the install screen. If the CD does not run, go to My Computer and click on the CD to open.

## Appendix A. POST Codes

This section provides the AMI POST Codes (Table 6) for the EVGA P67 SLI Motherboard during system boot up.

The POST Codes are displayed on the Debug LED readout located directly onboard the motherboard.

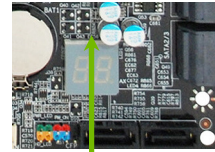

Debug LED with CPU Temperature Monitor

This Debug LED will also display current CPU temperatures after the system has fully booted into the Operating System.

**Table 6. AMI POST Code**

01	Power on. Reset type detection (soft/hard).
02	AP initialization before microcode loading
03	North Bridge initialization before microcode loading
04	South Bridge initialization before microcode loading
05	OEM initialization before microcode loading
06	Microcode loading
07	AP initialization after microcode loading
08	North Bridge initialization after microcode loading
09	South Bridge initialization after microcode loading
0A	OEM initialization after microcode loading
0B	Cache initialization
0C-0D	Reserved for future AMI SEC error codes
0E	Microcode not found
0F	Microcode not loaded
10	PEI Core is started
11-14	Pre-memory CPU initialization is started
15-18	Pre-memory North Bridge initialization is started
19-	Pre-memory South Bridge initialization is started

1C	
1D-2A	OEM pre-memory initialization codes
2B	Memory initialization. Serial Presence Detect (SPD) data reading
2C	Memory initialization. Memory presence detection
2D	Memory initialization. Programming memory timing information
2E	Memory initialization. Configuring memory
2F	Memory initialization (other).
30	Reserved for ASL (see ASL Status Codes section below)
31	Memory Installed
32	CPU post-memory initialization is started
33	CPU post-memory initialization. Cache initialization
34	CPU post-memory initialization. Application Processor(s) (AP) initialization
35	CPU post-memory initialization. Boot Strap Processor (BSP) selection
36	CPU post-memory initialization. System Management Mode (SMM) initialization
37-3A	Post-Memory North Bridge initialization is started
3B-3E	Post-Memory South Bridge initialization is started
3F-4E	OEM post memory initialization codes
4F	DXE IPL is started
50	Memory initialization error. Invalid memory type or incompatible memory speed
51	Memory initialization error. SPD reading has failed
52	Memory initialization error. Invalid memory size or memory modules do not match.
53	Memory initialization error. No usable memory detected
54	Unspecified memory initialization error.
55	Memory not installed
56	Invalid CPU type or Speed
57	CPU mismatch
58	CPU self test failed or possible CPU cache error
59	CPU micro-code is not found or micro-code update

	is failed
5A	Internal CPU error
5B	reset PPI is not available
5C-5F	Reserved for future AMI error codes
E0	S3 Resume is started (S3 Resume PPI is called by the DXE IPL)
E1	S3 Boot Script execution
E2	Video repost
E3	OS S3 wake vector call
E4-E7	Reserved for future AMI progress codes
E8-EB	S3 Resume Failed
EC-EF	Reserved for future AMI error codes
F0	Recovery condition triggered by firmware (Auto recovery)
F1	Recovery condition triggered by user (Forced recovery)
F2	Recovery process started
F3	Recovery firmware image is found
F4	Recovery firmware image is loaded
F5-F7	Reserved for future AMI progress codes
F8	Recovery PPI is not available
F9	Recovery capsule is not found
FA	Invalid recovery capsule
FB-FF	Reserved for future AMI error codes
60	DXE Core is started
61	NVRAM initialization
62	Installation of the South Bridge Runtime Services
63-67	CPU DXE initialization is started
68	PCI host bridge initialization
69	North Bridge DXE initialization is started
6A	North Bridge DXE SMM initialization is started
6B-6F	North Bridge DXE initialization (North Bridge module specific)
70	South Bridge DXE initialization is started

71	South Bridge DXE SMM initialization is started
72	South Bridge devices initialization
73-77	South Bridge DXE Initialization (South Bridge module specific)
78	ACPI module initialization
79	CSM initialization
7A-7F	Reserved for future AMI DXE codes
80-8F	OEM DXE initialization codes
90	Boot Device Selection (BDS) phase is started
91	Driver connecting is started
92	PCI Bus initialization is started
93	PCI Bus Hot Plug Controller Initialization
94	PCI Bus Enumeration
95	PCI Bus Request Resources
96	PCI Bus Assign Resources
97	Console Output devices connect
98	Console input devices connect
99	Super IO Initialization
9A	USB initialization is started
9B	USB Reset
9C	USB Detect
9D	USB Enable
9E-9F	Reserved for future AMI codes
A0	IDE initialization is started
A1	IDE Reset
A2	IDE Detect
A3	IDE Enable
A4	SCSI initialization is started
A5	SCSI Reset
A6	SCSI Detect
A7	SCSI Enable
A8	Setup Verifying Password
A9	Start of Setup
AA	Reserved for ASL (see ASL Status Codes section below)
AB	Setup Input Wait
AC	Reserved for ASL (see ASL Status Codes section below)

AD	Ready To Boot event
AE	Legacy Boot event
AF	Exit Boot Services event
B0	Runtime Set Virtual Address MAP Begin
B1	Runtime Set Virtual Address MAP End
B2	Legacy Option ROM Initialization
B3	System Reset
B4	USB hot plug
B5	PCI bus hot plug
B6	Clean-up of NVRAM
B7	Configuration Reset (reset of NVRAM settings)
B8- BF	Reserved for future AMI codes
C0- CF	OEM BDS initialization codes
D0	CPU initialization error
D1	North Bridge initialization error
D2	South Bridge initialization error
D3	Some of the Architectural Protocols are not available
D4	PCI resource allocation error. Out of Resources
D5	No Space for Legacy Option ROM
D6	No Console Output Devices are found
D7	No Console Input Devices are found
D8	Invalid password
D9	Error loading Boot Option (LoadImage returned error)
DA	Boot Option is failed (StartImage returned error)

## EVGA Glossary of Terms

1337 – This is reserved for EVGA level elite  
AC – Alternating Current  
ACPI - Advanced Configuration and Power Interface  
AFR – Alternate Frame Rendering  
APIC - Advanced Programmable Interrupt Controller  
ACPI – Advanced Configuration and Power Interface  
BCLK – Base Clock (or operating frequency of base system bus)  
BIOS - Basic Input Output System  
CD-ROM - Compact Disc Read-Only Memory  
CMOS - Complementary Metal-Oxide Semiconductor  
CPU – Central Processing Unit  
D-ICE – Dry Ice Cooling  
DDR2 - Double Data Rate 2  
DDR3 - Double Data Rate 3  
DIMM - Dual In-line Memory Module  
DMI – Direct Memory Interface  
DRAM - Dynamic random access memory  
DVD - Digital Versatile Disc  
DVI – Digital Video Interface  
FDC - Floppy Disk Controller

## EVGA P67 SLI Motherboard

FSB – Front Side Bus  
FTW – For The Win!  
GHz – Gigahertz  
GPU – Graphics Processing Unit  
HDD - Hard Disk Drive  
HDMI - High-Definition Multimedia Interface  
HDR – High Dynamic Range Lighting  
HPET - High Precision Event Timer  
HT – Hyper-Threading  
HSF - Heat Sink Fan  
I/O - Input/Output  
IDE - Integrated Drive Electronics  
IEEE - Institute of Electrical and Electronics Engineers  
IGP - Integrated Graphics Processors  
IMC – Integrated memory controller  
IRQ - Interrupt Request  
JBOD - Just a Bunch of Disks  
JEDEC - Joint Electron Device Engineering Council  
LAN - Local Area Network  
LCD - Liquid Crystal Display  
LGA – Land Grid Array  
LN2 – Liquid Nitrogen Cooling  
MAC - Media Access Control  
MCP - Media and Communications Processor  
MHz – Megahertz  
MMIO – Memory Mapped I/O  
NB - Northbridge  
NCQ - Native Command Queuing  
NIC - Network Interface Card  
NTFS - New Technology File System



OEM - Original Equipment Manufacturer  
PATA - Parallel Advanced Technology Attachment  
PCB - Printed Circuit Board  
PCI - Peripheral Component Interconnect  
PCIe - Peripheral Component Interconnect Express  
PCI-x - Peripheral Component Interconnect Extended  
POST – Power on Self Test  
PWM – Pulse Width Modulation  
QDR - Quad Data Rate  
QPI – Quick Path Interconnect  
RAID - Redundant Array of Inexpensive Disks  
RGB - Red Green Blue  
SATA - Serial Advanced Technology Attachment  
SB - Southbridge  
SCSI - Small Computer System Interface  
SFR – Split Frame Rendering  
SLI - Scalable Link Interface  
SPD - Serial Presence Detect  
SPDIF - Sony/Philips Digital Interconnect Format  
SPP - System Platform Processors  
SSD – Solid State Drive  
TCP/IP - Transmission Control Protocol/Internet Protocol  
USB - Universal Serial Bus  
VDroop - V-core Voltage Drop  
VGA - Video Graphics Array

# Compliance Information

## FCC Compliance Information

This device complies with FCC Rules Part 15. Operation is subject to the following two conditions: (1) This device may not cause harmful interference, and (2) this device must accept any interference received, including interference that may cause undesired operation. This equipment has been tested and found to comply with the limits for a Class B digital device, pursuant to Part 15 of the FCC Rules. These limits are designed to provide reasonable protection against harmful interference in a residential installation. This equipment generates, uses and can radiate radio frequency energy and, if not installed and used in accordance with the manufacturer's instructions, may cause harmful interference to radio communications. However, there is no guarantee that interference will not occur in a particular installation. If this equipment does cause harmful interference to radio or television reception, which can be determined by turning the equipment off and on, the user is encouraged to try to correct the interference by one or more of the following measures: (1) Increase the separation between the equipment and signal source, or (2) connect the equipment to an outlet on a circuit different from that to which the signal source is connected. Consult the dealer or an experienced computer technician for help. The use of shielded cables for connection of peripheral devices to the PC systems is required to ensure compliance with FCC regulations. Changes or modifications to this unit not expressly approved by the party responsible for compliance could void the user's authority to operate the equipment.

## CE Compliance Information

Generic Radiation Interference Standard for Information Technology Equipment. (EN 55022: 2006, Class B), (EN 61000-3-2: 2006), (EN 61000-3-3: 1995 + A1: 2001 + A2: 2005). Warning: This is a Class B product. In a domestic environment this product may cause radio interference in which case the user may be required to take adequate measure. Generic Immunity Standard for Information Technology Equipment. (EN 55024: 1998 + A1: 2001 + A2: 2003).

## Trademark & Copyright Information

2001-2011 EVGA Corp. EVGA, the EVGA logo and combinations thereof are trademarks of EVGA Corp. All brand names, company names, service marks, logos, and trademarks of the company, or its affiliates or licensors are trademarks or registered trademarks of the company or its subsidiaries, affiliates or licensors in the US and other countries. Other company, products and service names may be trademarks or service marks of others. EVGA reserves the right to terminate this license if there is a violation of its terms or default by the Original Purchaser. Upon termination, for any reason, all copies of Software and materials must be immediately returned to EVGA and the Original Purchaser shall be liable to EVGA.com CORP for any and all damages suffered as a result of the violation or default.

## Legal Information

All material including but not limited to, text, data, design specifications, diagnostics, graphics, logos, reference boards, files, images, drawings, and software including this document and the software itself (together and separately) is owned, controlled by, licensed to, or used with permission by Company and is protected by copyright, trademark, and other intellectual property rights. All is being provided "as is", EVGA Corporation makes no warranties, whether express or implied, statutory or otherwise with respect to the materials and expressly disclaims all implied warranties of non-infringement, merchantability, and fitness for a particular purpose. In no event shall the liability of EVGA Corporation for claims arising from the use of the materials by anyone exceed the original purchase price of the materials (or replacement of the materials at EVGA Corporation's option). All information furnished is believed to be accurate and reliable. However, EVGA Corporation assumes no responsibility for the consequences of use of such information or for any infringement of patents or other rights of third parties that may result from its use, or use of the Software. No license is granted by implication or otherwise under any patent or patent rights of EVGA Corporation except as expressly provided herein. All specifications mentioned in this publication are subject to change without notice.